

NDA Prioritisation Process And Hazard Baseline – NuSAC 3rd July 2008

Introduced by: Mark Wareing

London



Why NDA Prioritisation Process

- Requirement of energy act
- Vehicle for stakeholder engagement
- Provides a framework and common language to underpin decisions

The Prioritisation Process is about communication

What Is The NDA Prioritisation Process?

- Developed by Prioritisation Working Group
- **Only looks at remediation activities**
- Process split into three pieces
 - What concerns us most
 - What are we doing about it
 - How do we schedule this in against available funding
- Does not replace regulatory due process (Still necessary for duty holder to justify)
- Described in detail in NDA procedure EGPR02 which is on the web (www.nda.gov.uk)

What Concerns Us Most?

- Safety And Environmental Detriment Score (SED)

SED Score = **Potential detriment** + **Ongoing detriment**

- Radiological and chemical hazard potential
- Facility condition
- Uncertainty surrounding waste form
- On going impact on the environment as a result of facility not being remediated

Hazard Baseline

- SED Used As Basis Of Hazard Baseline
- Answers question if we looked at our estate today which facilities would concern us most
- Allows facilities and sites to be ranked on national scale
- Based on site schedules can provide measure of progress or assess alternatives
- Linked with waste conversion

SED - Site Rankings

Ranking	Site	Score	Comment
1	Sellafield	1E28	Driven by legacy facilities
2	Dounreay	3.3E24	
3	Chapelcross	5E21	Stored material
4	Windscale	8.8E19	
5	Harwell	6.5E19	
6	Trawsfynydd	4.7E19	
7	Berkeley	3.4E19	
8	Hunterston	2.8E18	
9	Capenhurst	1E18	Chemically contaminated land
10	Bradwell	6.5E15	
11	Springfields	7E14	Historic residues
12	Hinkley Point	5.6E14	
13	Sizewell	3.9E14	
14	Dungeness	3.9E14	
15	Bradwell	4.3E13	
16	Winfrith	1.6E10	
17	Oldbury	0	Operational
18	Wylfa	0	Operational
19	LLWR	0	Disposal Site

SED - National Picture

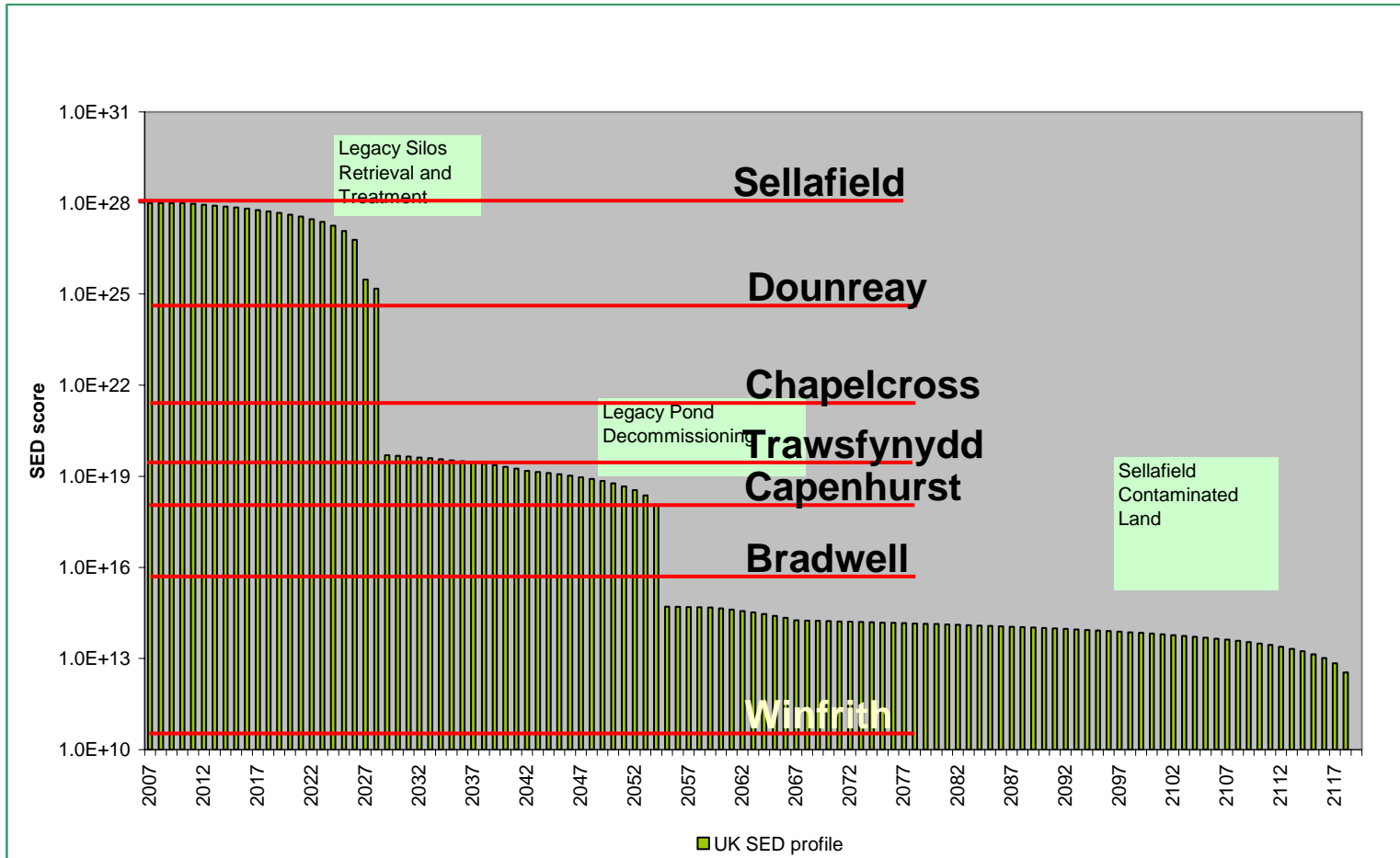

Outputs - National Waste Conversion

National Waste Inventory Breakdown by Volume

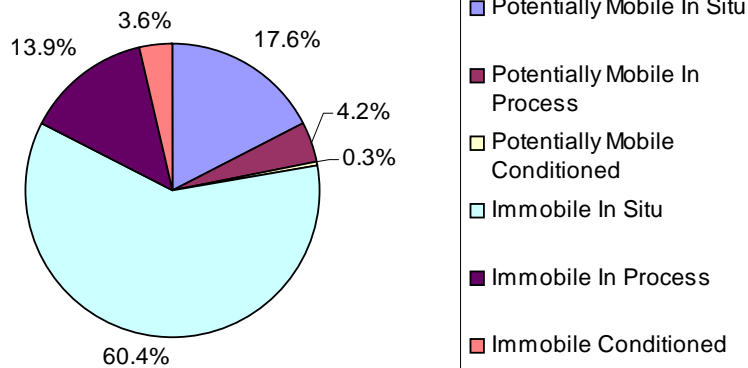

National Waste Inventory Breakdown by Activity

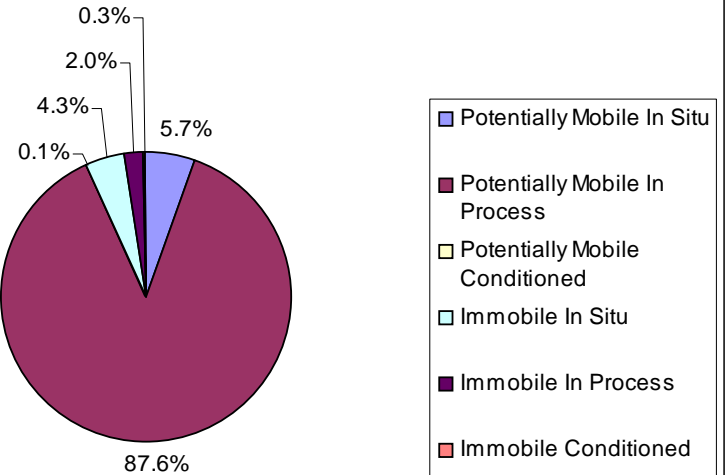

Outputs - National Waste Distribution

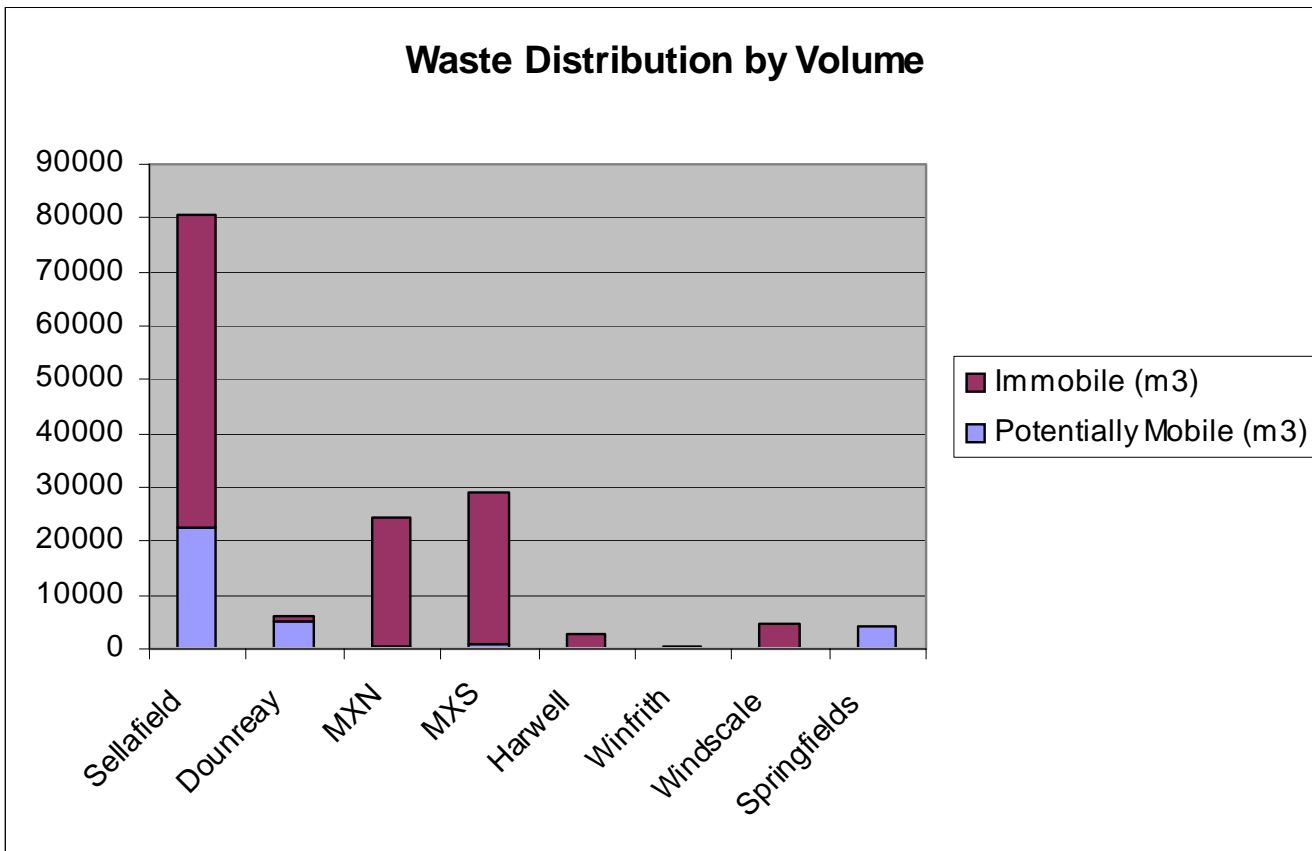

What Are We Doing About It?

- Identify projects to address concern
- Project benefit measure
 - Hazard reduction
 - Safety improvement
 - Value for money
 - Environmental mortgage
 - Advancing programme
- Other issues can be modifiers
- More detailed presentation provided and available on NDA web site

How Do We Schedule Against Available Funding

- Reconcile SED (facility) Scores against Project Scores
- Schedule on basis of project scores taking account of adjustments for high SED facilities

Scheduling Process

- NDA define indicative Site funding Limit
- SLC define and schedule activities required to keep site Safe and Secure
- SLC define and schedule existing commercial commitments
- Remaining funds to be spend on time discretionary activities – i.e. remediation work

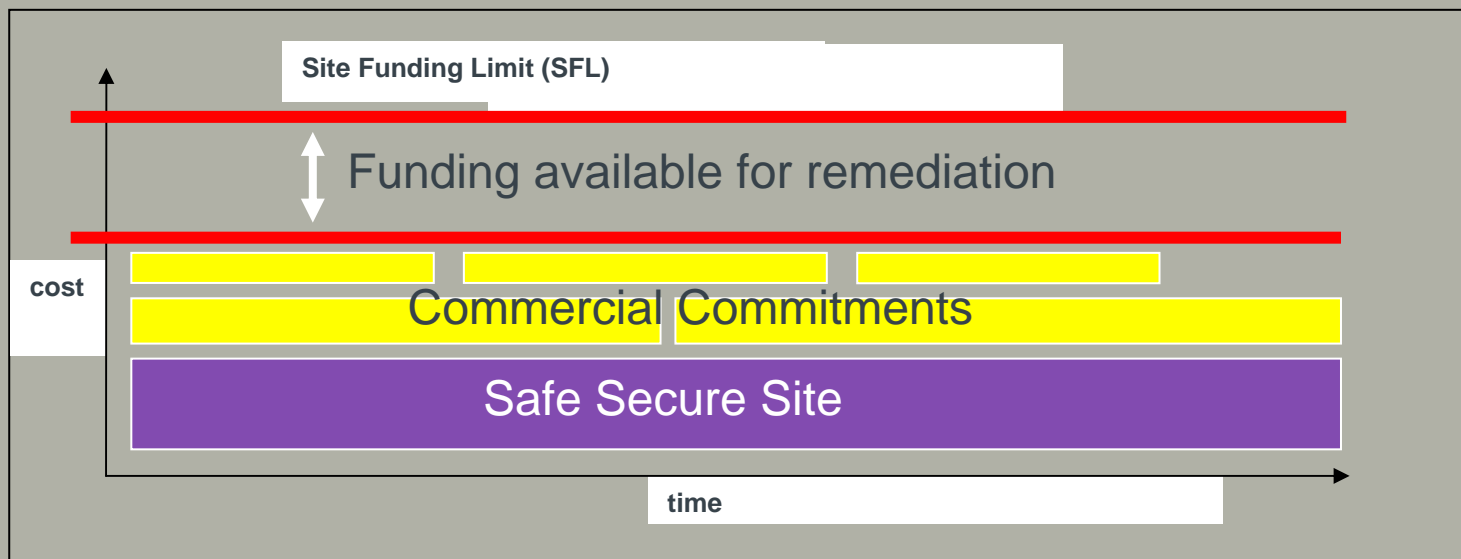

Scheduling

If only one project could be done at a time – based on adjusted ranking list

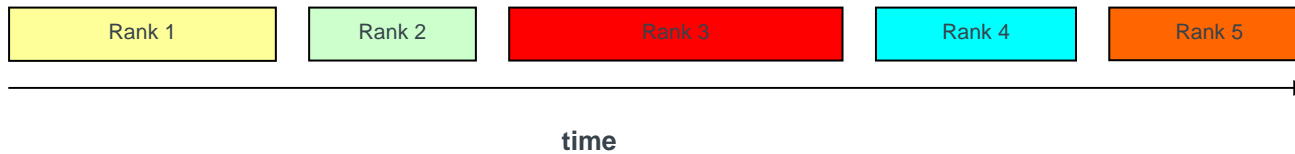

Intelligent Scheduling

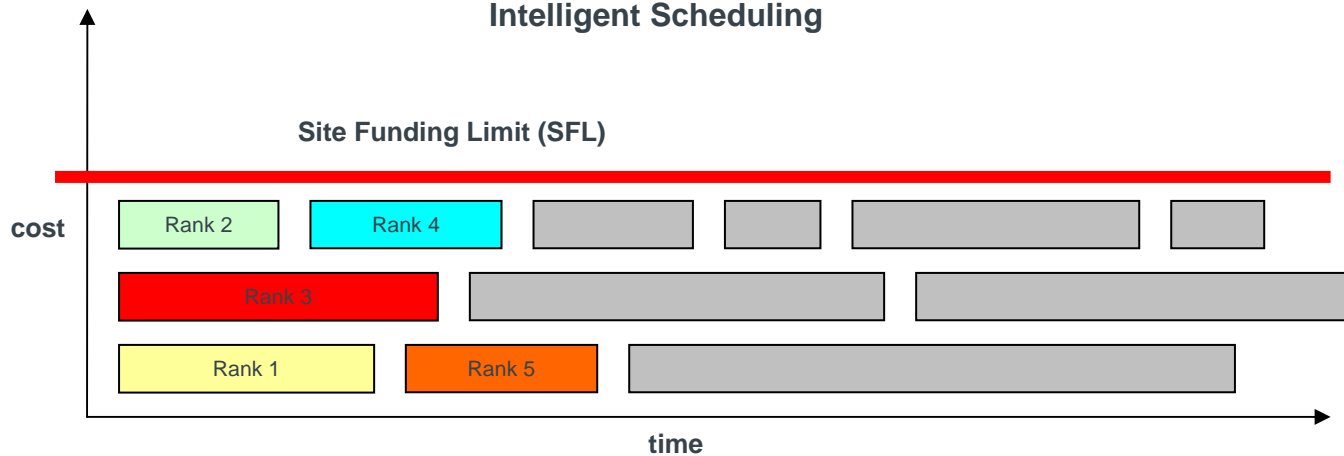

Scheduling

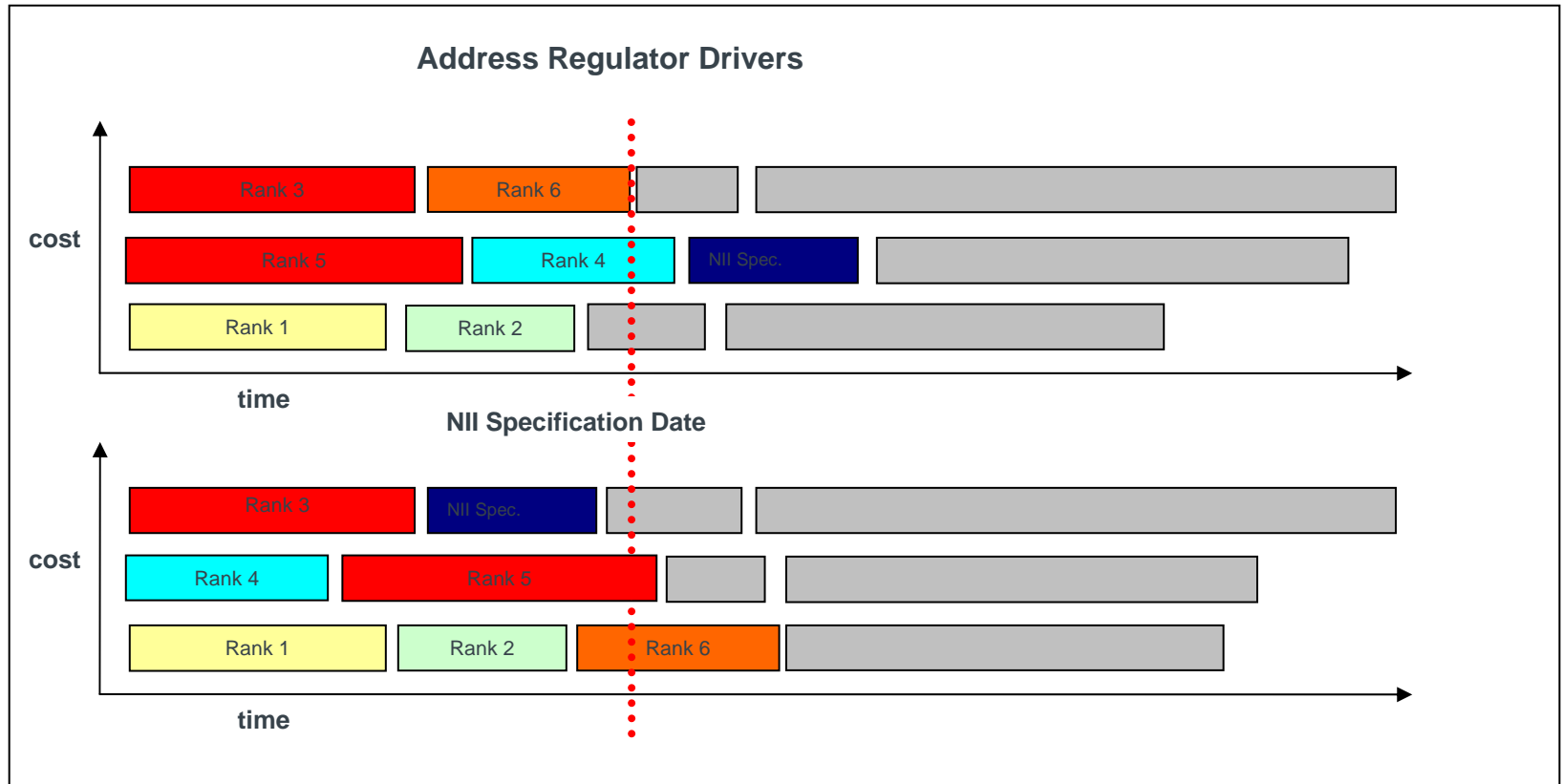

Scheduling

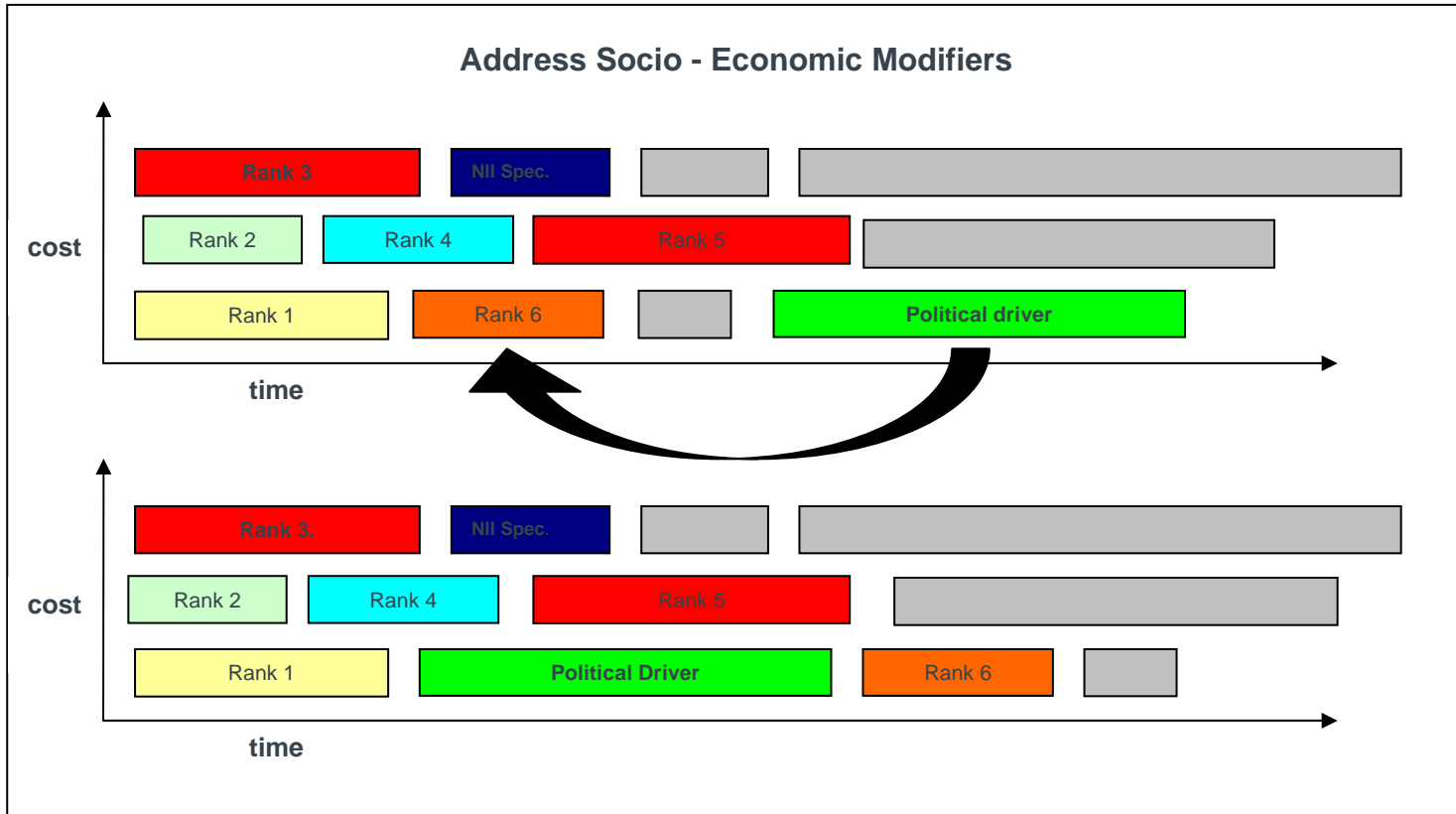

Scheduling

Key thing is audit trail

How Does NDA Decide On Distribution Of Funds?

Value Framework

- Takes wider perspective than prioritisation
- Looks at how as well as why
- Need to use as we develop it as have to constantly make decisions
- Near term focus setting Annual Site Funding Limits – Draft guidance Oct 08

Where We Would Like To Get To - Business Case

